

SEMIKRON

innovation + service

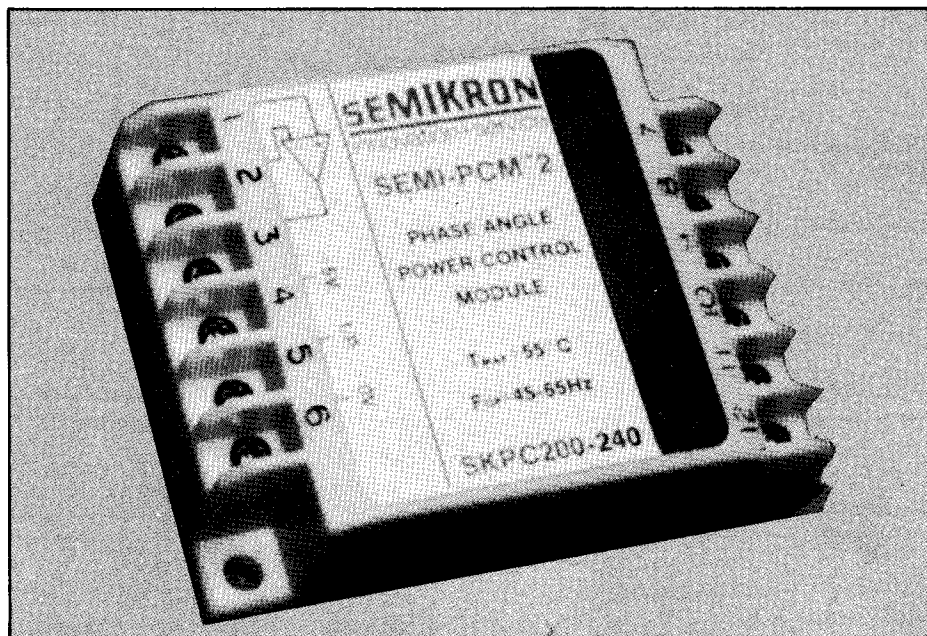

SKPC200
PHASE ANGLE
CONTROL

SKPC 200 is one of the new generation of Semikron Power Control Modules (SEMI-PCM). The new high specification design provides an optimum level of isolated gate drive for a wide range of SCR's connected to form powerful AC to AC regulators or AC to DC Power Supplies.

The new design can be used to control most of the standard power circuits such as WIC, B2HZ and B2HK. SKPC 200 can be powered from a separate aux.power supply thus allowing the SCR power circuit to be operated on NON-STANDARD voltages.

The new design incorporates a number of very important features such as GATE STEERED firing required for highly inductive loads, un-committed OP-AMP to allow FEEDBACK control, and gate output drive SHORT CIRCUIT protected. Additionally both 50/60HZ can be accommodated and internal 5V ref. has a HIGH OUTPUT current capability ideal to power EXTERNAL control circuits.

The excellent package, which integrates an internal supply transformer, is fully compatible for mounting with SEMIPACK 1 to SEMIPACK 4 SCR modules. The input and output SCREW terminal connections are both electrically and mechanically isolated.

MAIN FEATURES

- * Fully Isolated protected input
- * Aux.5V Supply
- * Internal Supply TRF
- * Conforms to UL, CSA and VDE requirements
- * Short Circuit protected
- * High specification

TYPICAL APPLICATIONS

- * Heating Loads
- * Power Supplies
- * High inrush current loads
- * DC injection braking
- * Motor Control

PRODUCT TYPES:

SKPC200 - 115
 SKPC200 - 240
 SKPC200 - 440

FOR VOLTAGE SUPPLY OF 115Vrms
 FOR VOLTAGE SUPPLY OF 240Vrms
 FOR VOLTAGE SUPPLY OF 440Vrms

ELECTRICAL SPECIFICATIONS:

Operating Supply Voltage Nom. + 10%, -15%
 Operating Frequency 45 - 65Hz
 Input Control/Impedance 0 - 5V/100K Ohm min.
 Controllable Retard Angle 180 Degrees typical
 Peak Gate Output Current 1.9A @ Vs = Max. @90° Angle
 Gate Short Circuit Response 250 - 500mSec.
 Critical Dv/Dt 500V/μS min. for 240V type
 100V/μS min. for 440V type
 Reference Output Aux. Voltage 5V @ 20mA min.
 Uncommitted OP-AMP Input Voltage +/- 10V Terminal 1 & 2
 Uncommitted OP-AMP Output Swing +/- 10V Terminal 3
 Input/Output Isolation 2.5KV rms

MECHANICAL SPECIFICATIONS:

Storage Temperature -40°C to +125°C
 Operating Temperature/Humidity 0 to + 55°C/80%RH
 Flame Retardance UL94 - VO
 Weight 320gms
 Mounting 80mm Centres, 2Nm Torque
 Hardware Supplied 2 x M5 Mounting Screws

MECHANICAL OUTLINE

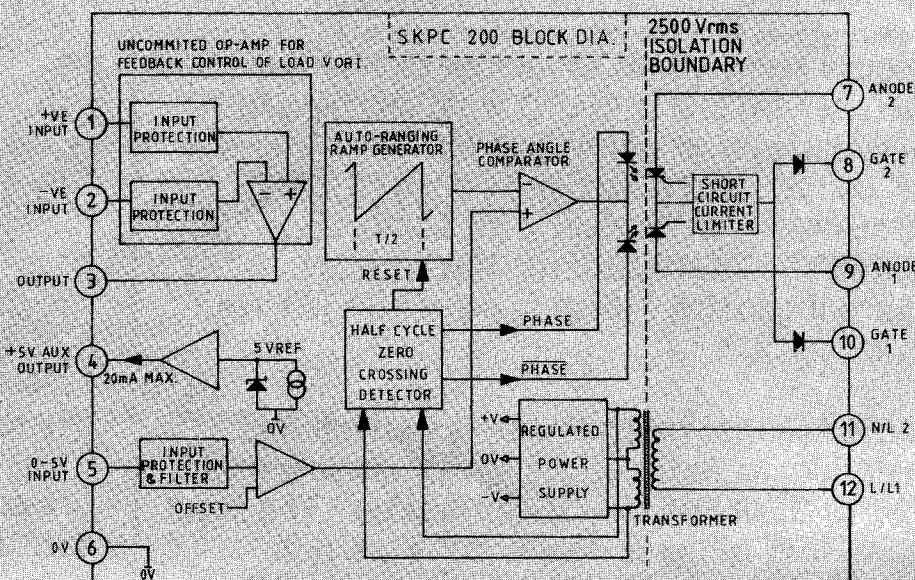
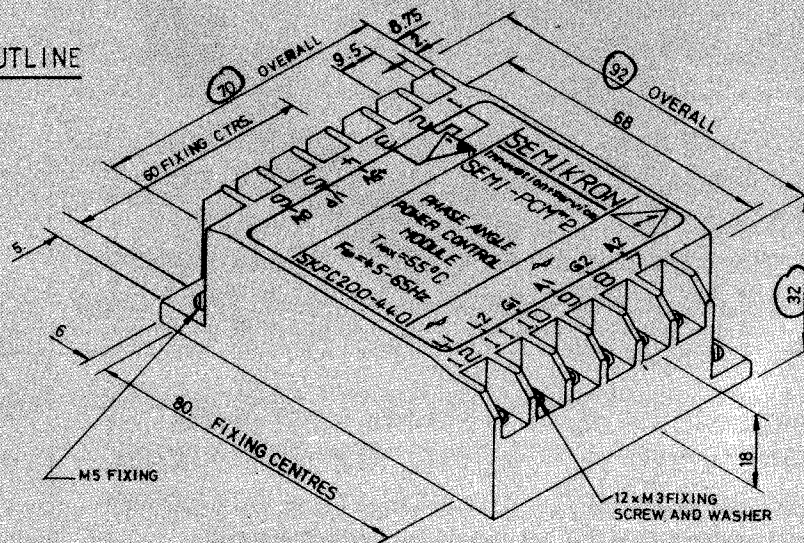

* RECOMMENDED PROTECTIVE COMPONENTS APPLICABLE TO ALL CCTS, AS FOLLOWS.

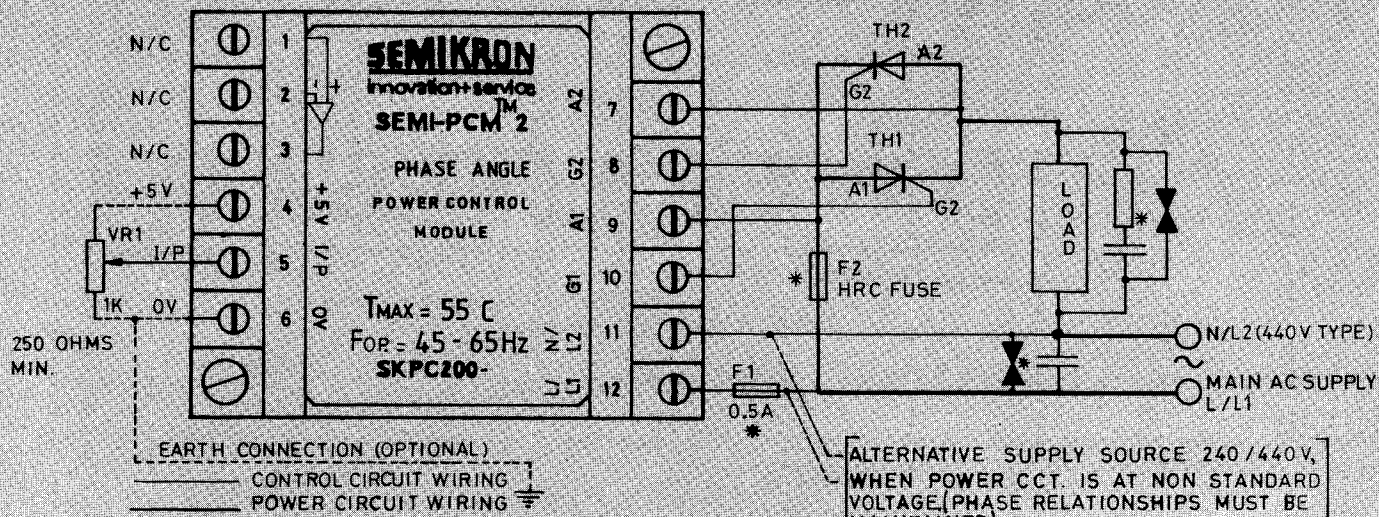

BASIC A.C. REGULATOR (WIC) WIRING

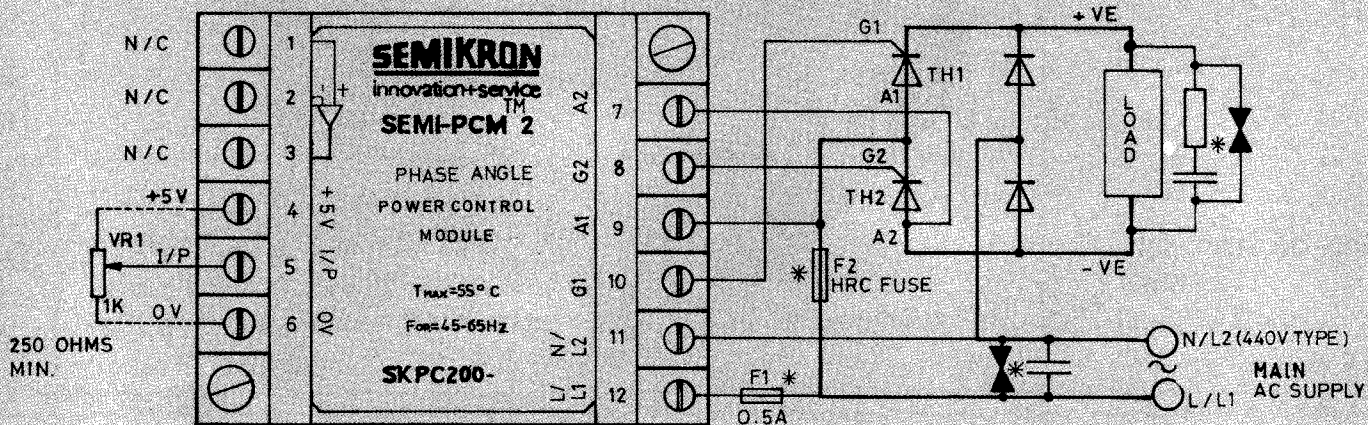

HALF CONTROLLED D.C. BRIDGE (B2HZ) WIRING

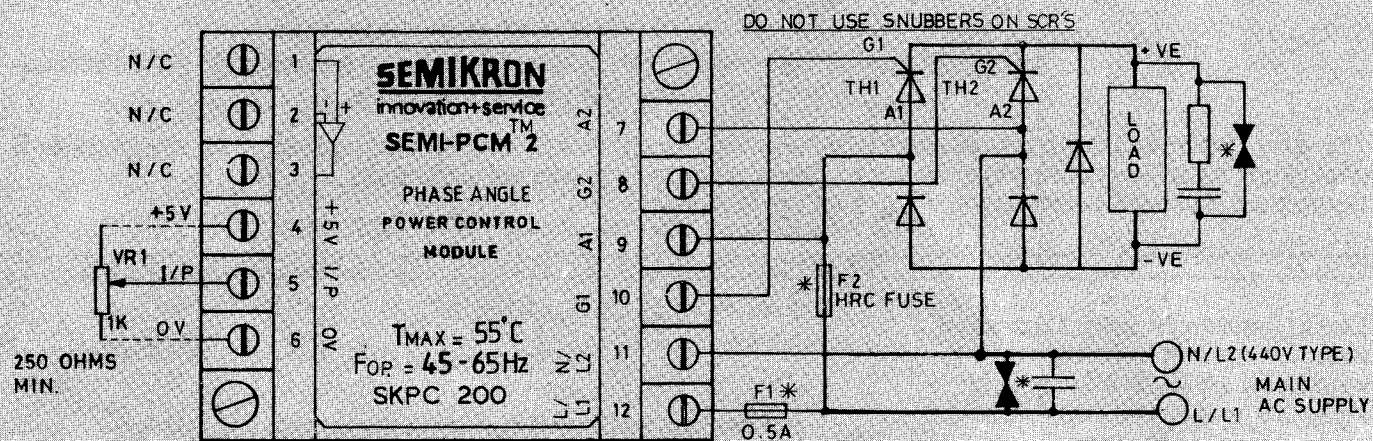

ALTERNATIVE HALF CONTROLLED D.C. BRIDGE (B2HKF)

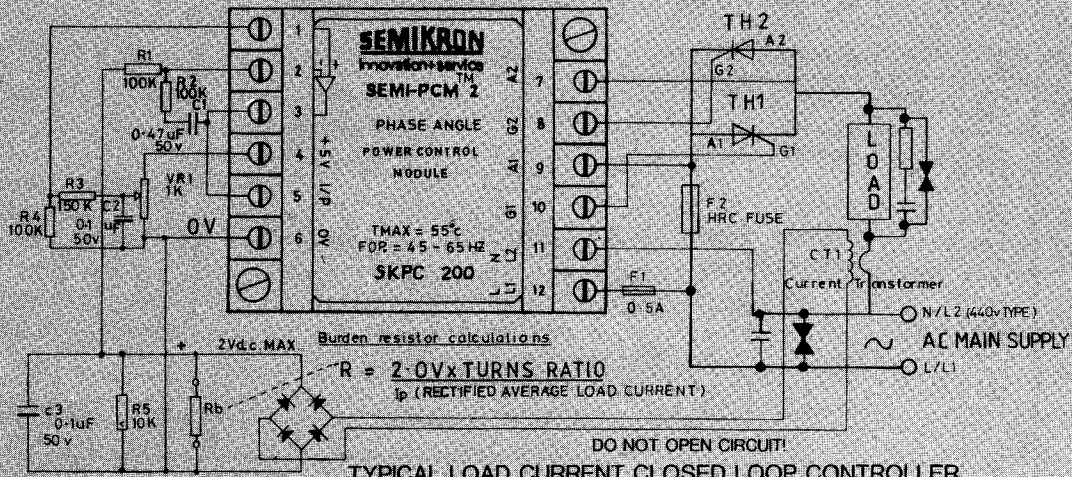

(FOR VOLTAGE FEED BACK CONTROL REPLACE CT1 WITH A VOLTAGE TRANSFORMER AND CONNECT PRIMARY ACROSS THE LOAD TO ISOLATE FEEDBACK SIGNAL)
 NOTE: ALL ABOVE EXTERNAL COMPONENTS ARE OF SUGGESTED VALUES. EXPERIMENTATION IS NECESSARY TO OPTIMISE, PARTICULARLY R2 & C1 TO SUIT DIFFERENT TIME CONSTANTS OF APPLICATIONS.

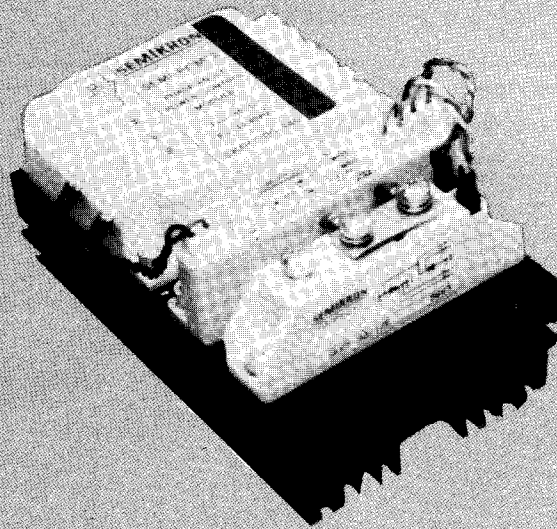

Within this SEMI-PCM range, there are a number of other Power Control Modules as follows:

SKPC100

- Zero Voltage or Instantaneous trigger control module to interface low level TTL/CMOS circuits with power SCR's

SKPC150 I.C.

- A 20 pin custom Microchip for multi-channel digital phase angle control. Parallel or serial interface to micro-processors for controlling thyristors.

SKPC300

- Three Phase Thyristor Controller for both AC to AC or AC to DC bridge applications.

SKPC500

- Low cost Burst Firing Controller for heating loads

SKPC600

- Precision Burst Firing Controller with compensation for supply voltage variation and maximum power limit facility

The above controllers can be supplied as fully assembled Power Semiconductor assemblies - SEMISTACK (refer to photograph as above) consisting of heatsinks, fuses, snubber networks and SCR's etc. Contact our Sales Office for custom designs for specific applications.

Due to Semikron's policy of constant improvement and technical innovation, we reserve the right to make changes in these specifications at any time without notice.

SEMIKRON

innovation + service

4 Marshgate Drive
 Hertford. SG13 7BQ
 TEL: 0992 584677
 FAX: 0992 554942
 TLX: 81125



FM No. 09933